

PPB-350-EP4-- Underpinning Bracket

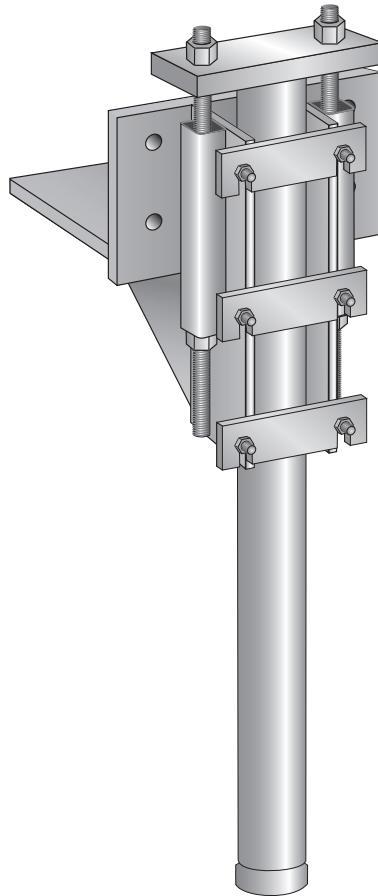

Product Specifications

Product Style	Underpinning Bracket
Component	PPB-350-EP4 Steel Pier (6-1/2" Pier Offset)
Capacity	42 Kip
Bearing Surface	74 Square Inches
Lift Capacity	Fully Adjustable for Unlimited Lift
Coating	Black (Optional Hot Dip Galvanized)
Pier Pipe Spec	ASTM A500
Standard Package	1
Standard Package Unit	Each Bracket Only & 4" OD x .220 Wall x 42" long Sleeve
Weight	165 lbs.

Notes

Underpinning Bracket Assembly

Optional: PPB-350-IP, PPB-350-SB and High Strength Non-Shrink Grout